

集装箱房屋
Container house



采用钢结构整体式框架设计，墙面及屋面进行保温隔热处理，同时具有防水、隔音等特性，安全耐用，可根据需要任意组合，方便运输、吊装。
Using steel structural frame design, the house is thermal insulated, waterproof and soundproof, it's also safe, durable and convenient for transportation, available for flexible combination.

集装箱改造
Shipping containers modification



由海运集装箱改造，具有良好的隔音、保温隔热特性，并且坚固耐用，可根据客户需求提供定制服务。
Modified from shipping containers, the house is soundproof and thermal insulated, also safe and durable. We provide customized modification services.

定制服务
Customization services



我们为客户提供多样化的房屋定制服务，涵盖了产品设计、工厂预制、现场施工及后期室内装潢。我们以节能环保的产品，为客户量身打造高效可靠的住房解决方案。
We provide customization services to our customers, diversified choices including: product design, factory prefabrication, site construction and interior decoration. With energy saving and environmental friendly products, we deliver tailored, efficient and reliable housing solutions for you.



海外销售市场
Overseas sales market



公司80%以上的产品出口海外，销往全球多个国家和地区，积累了丰富的生产经验，产品质量和服务得到广泛认可。
More than 80% of our products are exported globally, accumulated rich construction experience, the quality of products and services are widely recognized.

集装箱房屋结构
Structure of container house

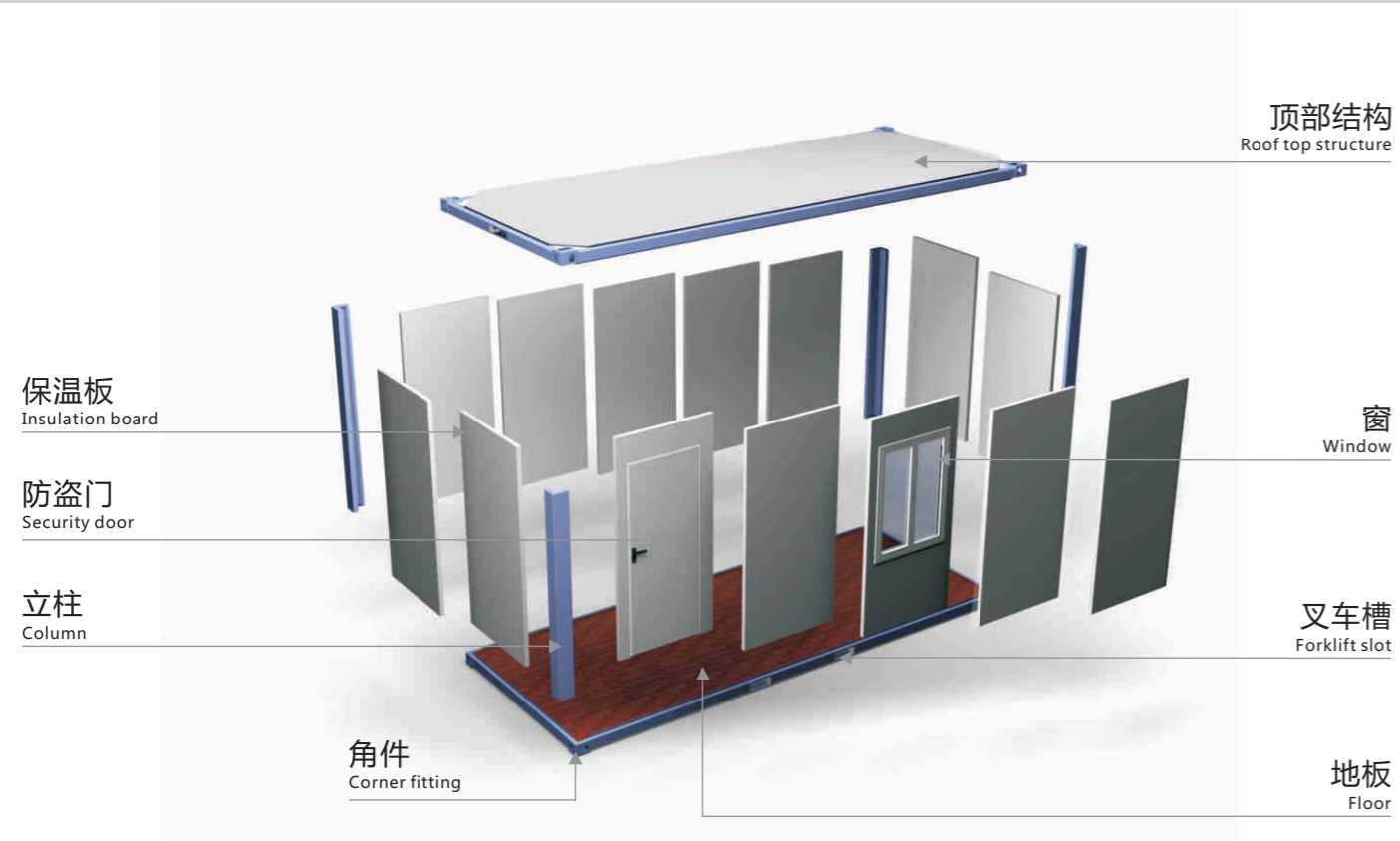

室内展示
Interior display



集装箱说明
Container house instruction

集装箱房屋是以集装箱为基本模块，采用制造模式，在工厂完成各模块的结构建造和内部装修，并能按不同的用途和功能在工程现场快速组合成各种风格的房屋建筑。内部装修符合当地国家水、电、防火、隔音、保温、环保等所有规范要求。可满足客户对低中高端建筑的不同要求。房屋充分考虑到运输的可行性，可以用传统的运输方式完成海运和陆运。

Container houses are based on shipping containers, module structure construction and interior decoration are finished in the factory using manufacturing production. These modules can be fast assembled into houses with various styles according to different uses and functions on site. Interior decoration, in accordance with local national standards for water, electric, Fireproof, sound insulation, heat preservation, environmental protection and all other requirements.

集装箱房屋产品优势
Advantages of container houses

集装箱房屋可以大量缩短建造时间，更具灵活性和移动性。比传统建造方式更安全、更安静、更环保，有效地保证了质量的稳定性和连续性。同时给建筑设计提供了更大的柔性。

Container houses can significantly shorten the construction period, more flexibility and mobility. Safer than traditional construction, quieter, more environmentally friendly and effective to ensure the stability and continuity of quality. Provides greater flexibility to the architectural design.

XYZ-1		
尺寸 Dimensions	长(L)	6055mm
	宽(W)	4870mm
	高(H)	2640mm
面积 Area	29.50m ²	
标准配置 Configuration	卧室Bedroom 淋浴房Shower room 卫生间Toilet 洗手盆Wash basin 厨房kitchen cabinet	

平面图
Floor Plan

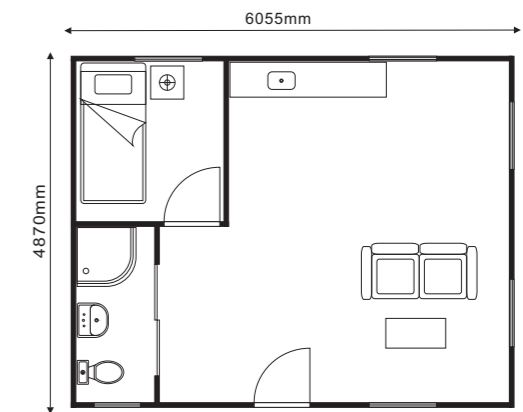

XYJ-01		
尺寸 Dimensions	长(L)	6055mm
	宽(W)	2435mm
	高(H)	2640mm
面积 Area	14.75m ²	
标准配置 Configuration	卧室Bedroom 淋浴房Shower room 卫生间Toilet 洗手盆Wash basin	
平面图 Floor Plan		

XYJ-02		
尺寸 Dimensions	长(L)	6055mm
	宽(W)	2435mm
	高(H)	2640mm
面积 Area	14.75m ²	
标准配置 Configuration	卧室Bedroom 淋浴房Shower room 卫生间Toilet 洗手盆Wash basin	
平面图 Floor Plan		

XYJ-03		
尺寸 Dimensions	长(L)	6055mm
	宽(W)	2435mm
	高(H)	2640mm
面积 Area	14.75m ²	
标准配置 Configuration	卧室Bedroom	
平面图 Floor Plan		



XYJ-04		
尺寸 Dimensions	长(L)	6055mm
	宽(W)	2435mm
	高(H)	2640mm
面积 Area	14.75m ²	
标准配置 Configuration	卧室Bedroom 淋浴房Shower room 卫生间Toilet 洗手盆Wash basin 厨房kitchen	
平面图 Floor Plan		



XYC-01		
尺寸 Dimensions	长(L)	5850mm
	宽(W)	2250mm
	高(H)	2500mm
面积 Area	13.16m ²	
标准配置 Configuration	卫生间Toilet 洗手盆Wash basin	
平面图 Floor Plan		

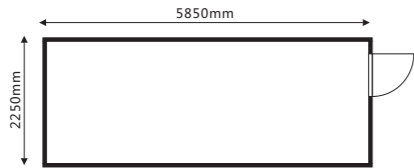

XYC-02		
尺寸 Dimensions	长(L)	5850mm
	宽(W)	2250mm
	高(H)	2500mm
面积 Area	13.16m ²	
标准配置 Configuration	卫生间Toilet 洗手盆Wash basin	
平面图 Floor Plan		

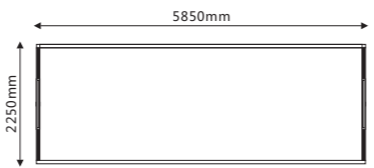

XYL-01		
尺寸 Dimensions	长(L)	5850mm
	宽(W)	2250mm
	高(H)	2500mm
面积 Area	13.16m ²	
标准配置 Configuration	淋浴房Shower room	
平面图 Floor Plan		

XYK-01		
尺寸 Dimensions	长(L)	3000mm
	宽(W)	2250mm
	高(H)	2500mm
面积 Area	6.75m ²	
标准配置 Configuration		
平面图 Floor Plan		

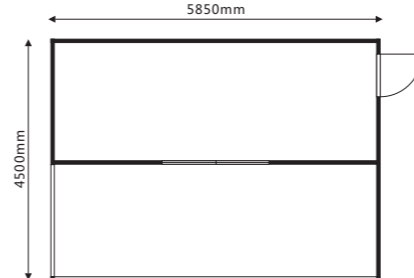
XYK-02		
尺寸 Dimensions	长(L)	5850mm
	宽(W)	2250mm
	高(H)	2500mm
面积 Area		13.16m ²
标准配置 Configuration		
平面图 Floor Plan		
		
		

XYK-03		
尺寸 Dimensions	长(L)	5850mm
	宽(W)	2250mm
	高(H)	2500mm
面积 Area		13.16m ²
标准配置 Configuration		
平面图 Floor Plan		
		
		

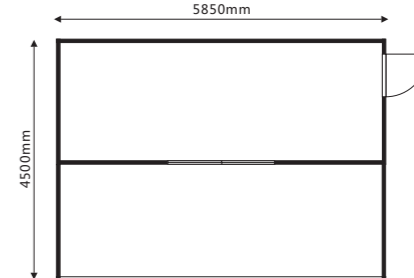
XYK-04		
尺寸 Dimensions	长(L)	5850mm
	宽(W)	4500mm
	高(H)	2500mm
面积 Area		26.33m ²
标准配置 Configuration		
平面图 Floor Plan		
		
		

XYK-05		
尺寸 Dimensions	长(L)	5850mm
	宽(W)	4500mm
	高(H)	2500mm
面积 Area		26.33m ²
标准配置 Configuration		
平面图 Floor Plan		
		
		

XYJ-41		
尺寸 Dimensions	长(L)	11900mm
	宽(W)	2435mm
	高(H)	2640mm
面积 Area	28.98m ²	
标准配置 Configuration	卧室Bedroom 淋浴房Shower room 卫生间Toilet 洗手盆Wash basin 厨房kitchen	
平面图 Floor Plan		

XYJ-42		
尺寸 Dimensions	长(L)	11900mm
	宽(W)	2435mm
	高(H)	2640mm
面积 Area	28.98m ²	
标准配置 Configuration	卧室Bedroom 淋浴房Shower room 卫生间Toilet 洗手盆Wash basin 厨房kitchen	
平面图 Floor Plan		

XYJ-43		
尺寸 Dimensions	长(L)	11900mm
	宽(W)	2435mm
	高(H)	2640mm
面积 Area	28.98m ²	
标准配置 Configuration	卧室Bedroom 淋浴房Shower room 卫生间Toilet 洗手盆Wash basin	
平面图 Floor Plan		

XYJ-44		
尺寸 Dimensions	长(L)	11900mm
	宽(W)	2435mm
	高(H)	2640mm
面积 Area	28.98m ²	
标准配置 Configuration	卧室Bedroom 淋浴房Shower room 卫生间Toilet 洗手盆Wash basin	
平面图 Floor Plan		

扩展式箱房介绍

Introduction of expandable container house -- TIO



“一变三”：只需10分钟就能组装好的房子！
萧雅自主研发的“一变三”扩展式箱房不仅组装方便、可经常变换场地使用，而且可提供38㎡的使用面积，让移动居住也有大空间！

TIO--“Three in one”: The house can be assembled in just 10 minutes!
Xiaoya self-developed “TIO” is convenient to assemble, can be moved frequently, more importantly, it has using area up to 38㎡, large space for mobile living!

局部展示
Part show



扩展房照片

Expansion house photo



扩展房生产周期约为20天，在工厂已全部组装好，运输时房子折叠起来整体运输，节省空间，运到目的地后展开即可使用，快速方便。

The production period of TIO is approx. 20 days, all fittings have all been assembled in the factory, the house will be folded to save space during transportation, when shipped to destinations TIO can be quickly and easily installed.

两种推荐尺寸:

Two recommended dimensions:

长5850mm * 宽2250mm * 高2500mm (折叠后尺寸),
长5850mm * 宽6530mm * 高2500mm (展开后尺寸), 这样的尺寸便于使用40尺高柜运输。
L 5850mm * W 2250mm * H 2500mm (Folded size)
L 5850mm * W 6530mm * H 2500mm (Expanded size) Use 40ft HC for transportation, low shipping cost !

长5850mm * 宽2100mm * 高3200mm (折叠后尺寸),
长5850mm * 宽7300mm * 高3200mm (展开后尺寸), 这样的尺寸使得室内高度更为充裕, 但必须用开顶柜进行运输, 客户可以根据需求灵活地进行室内空间划分。
L 5850mm * W 2100mm * H 3200mm (Folded size)
L 5850mm * W 7300mm * H 3200mm (Expanded size)
TIO with this size has abundant indoor height, but can only be transported by open top container, you can also divide the indoor space flexibly.

我们还可以根据客户的要求生产不同规格的扩展房。
We also provide customization according to your requirements.

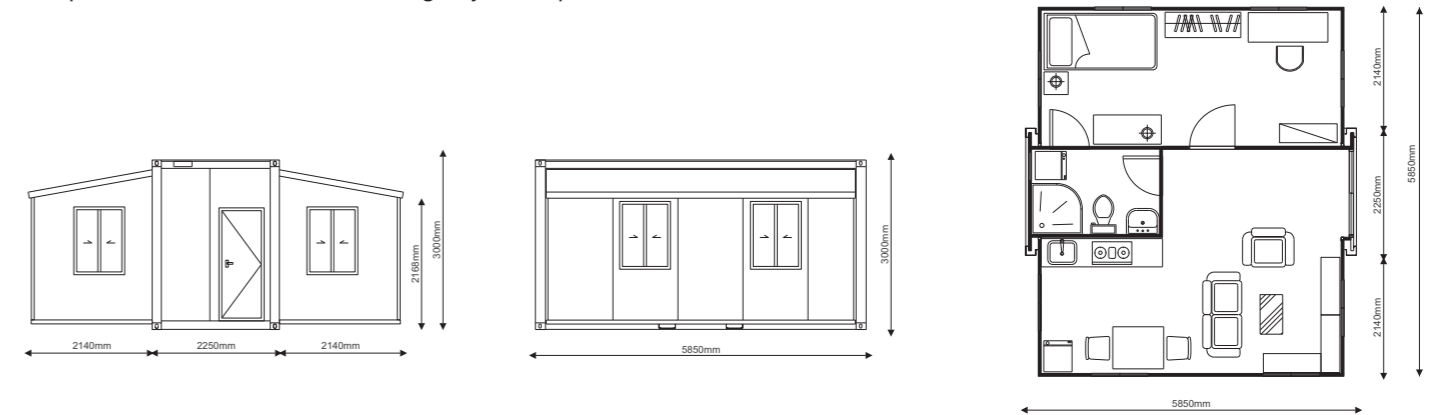

扩展房安装示意图

Expansion house installation diagram

本款扩展式箱房安装简便，只需五个步骤即可完成
Just 5 steps to complete a TIO installation

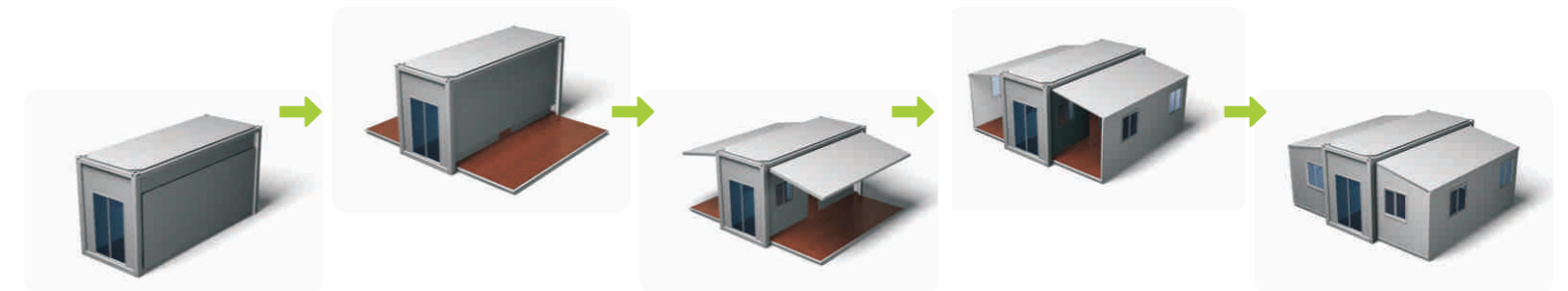

扩展式箱房介绍

Introduction of expandable container house -- TIO 2.0



TIO 2.0是萧雅在一代TIO系列基础上发展而来的新型产品，继承了TIO系列--“移动居住大空间”的设计理念，结构精巧，重量减小，灵活性更强。
TIO 2.0 is an evolutionary upgrade of TIO series, inherited the "Large mobile living space" design philosophy of TIO series, possesses compact structure, reduced weight and greater flexibility.

局部展示
Part show



扩展房照片

Expansion house photo



扩展房生产周期约为20天，在工厂已全部组装好，运输时房子折叠起来整体运输，节省空间，运到目的地后展开即可使用，快速方便。

The production period of TIO is approx. 20 days, all fittings have all been assembled in the factory, the house will be folded to save space during transportation, when shipped to destinations TIO can be quickly and easily installed.

尺寸图:

Dimensions:

折叠后尺寸：长5850mm*宽620mm*高2500mm

展开后尺寸：长5850mm*宽5100mm*高2500mm

一个40尺高柜可装运六套，极大地节约了运输费用。

L5850mm*W620mm*H2500mm (Folded size)

L5850mm*W5100mm*H2500mm (Expanded size)

One 40ft HC may load 6 sets TIO 2.0, thus transportation costs can be greatly reduced.

我们还可以根据客户的要求生产不同规格的扩展房。

We also provide customization according to your requirements.

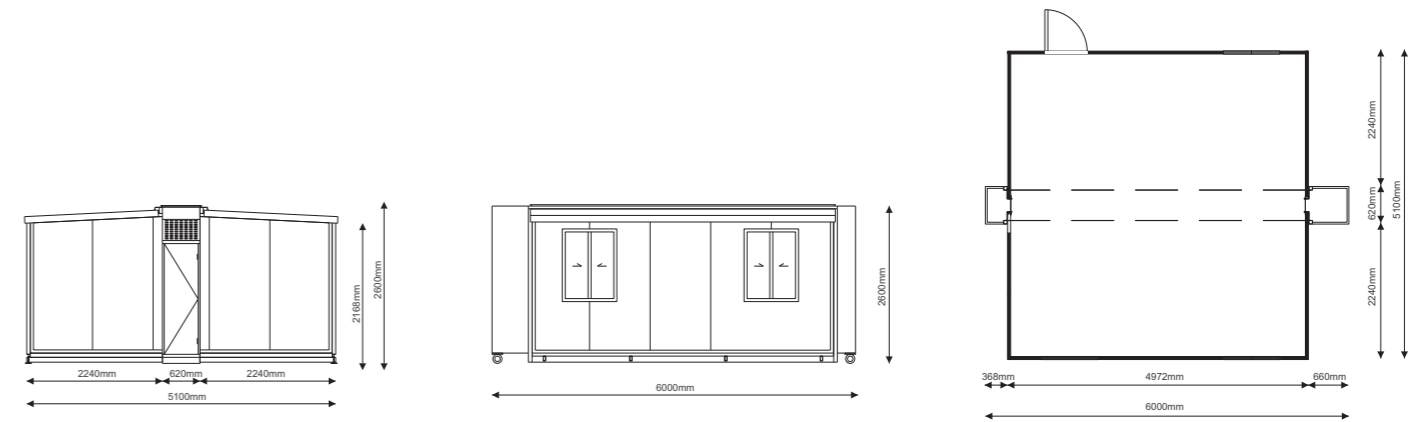

扩展房安装示意图

Expansion house installation diagram

本款扩展式箱房安装简便，只需五个步骤即可完成

Just 5 steps to complete a TIO 2.0 installation

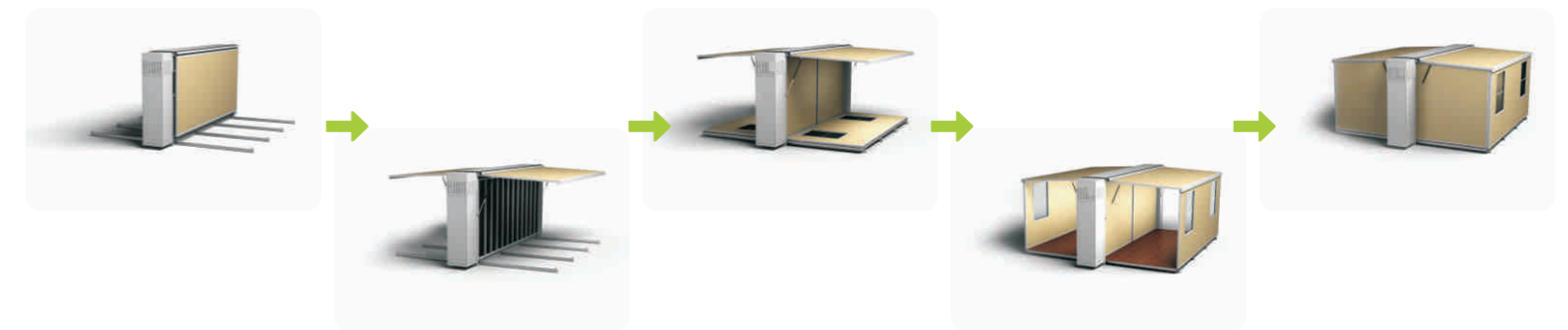



拖车厕所
Mobile toilets

萧雅自主研发的移动环保厕所，提供了灵活高效的临时厕所解决方案，采用循环水系统，最大限度节省资源，保护环境。
Xiaoya self-developed environment-friendly mobile toilets provides flexible and efficient temporary toilet solutions, equipped with circulating water system, can maximize conserving resources and protecting the environment.

活动房
Prefabricated house

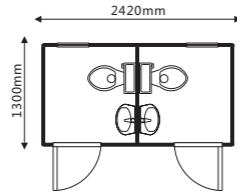
为解决活动板房运输和安装的不便，萧雅设计了一系列折叠式带底座活动房，既能方便地打包运输，也能快速地进行现场组装。
To solve the transportation and installation inconvenience of traditional prefab panel house, Xiaoya designed a series of steel frame based foldable prefab panel house, which can be easily packaged, transported and quickly assembled on site.

XYT-01		平面图 Floor Plan	
尺寸 Dimensions	长(L)	2420mm	
	宽(W)	1300mm	
	高(H)	2000mm	
排污处理 Sewage treatment	污水循环冲刷系统 Sewage recycling treatment system, flushing the toilet using sewage		
标准配置 Configuration	卫生间Toilet 洗手盆Wash basin		

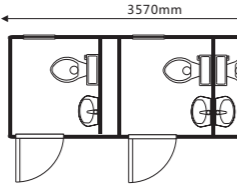
XYT-02		平面图 Floor Plan	
尺寸 Dimensions	长(L)	3570mm	
	宽(W)	1300mm	
	高(H)	2000mm	
排污处理 Sewage treatment	污水循环冲刷系统 Sewage recycling treatment system, flushing the toilet using sewage		
标准配置 Configuration	卫生间Toilet 洗手盆Wash basin		

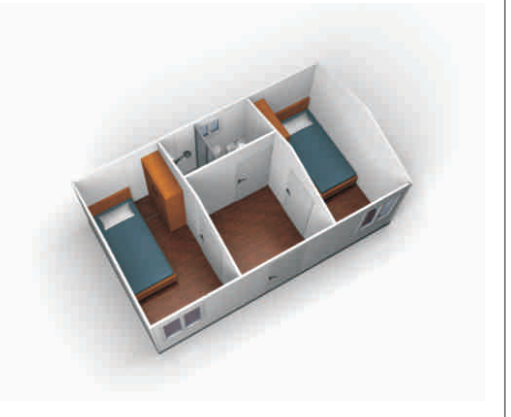
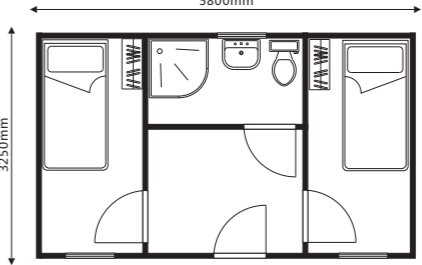
XYZ-01		平面图 Floor Plan	
尺寸 Dimensions	长(L)	5800mm	
	宽(W)	3250mm	
	高(H)	2100mm	
面积 Area	18.85m ²		
标准配置 Configuration	卧室Bedroom 淋浴房Shower room 卫生间Toilet 洗手盆Wash basin		

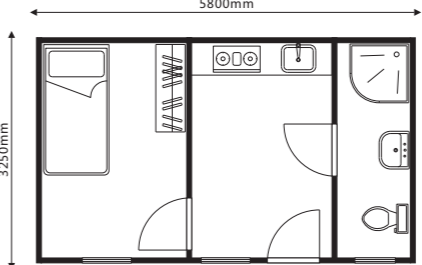
XYZ-02		平面图 Floor Plan	
尺寸 Dimensions	长(L)	5800mm	
	宽(W)	3250mm	
	高(H)	2100mm	
面积 Area	18.85m ²		
标准配置 Configuration	卧室Bedroom 淋浴房Shower room 卫生间Toilet 洗手盆Wash basin 厨房kitchen		

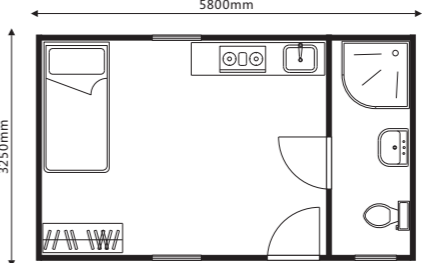
XYZ-03		平面图 Floor Plan	
尺寸 Dimensions	长(L)	5800mm	
	宽(W)	3250mm	
	高(H)	2100mm	
面积 Area	18.85m ²		
标准配置 Configuration	卧室Bedroom 淋浴房Shower room 卫生间Toilet 洗手盆Wash basin 厨房kitchen		

变电房介绍
Box-type transformer station

箱变的概述：箱式变电站（简称箱变），是一种高压开关设备、配电变压器和低压配电装置，按一定接线方案将高压受电、变压器降压、低压配电等功能有机地组合在一起，安装在一个防潮、防锈、防尘、防鼠、防火、防盗、隔热、全封闭、可移动的钢结构箱体内，全封闭运行，特别适用于城网建设与改造。由于它具有组合灵活，便于运输、迁移、安装方便，施工周期短、运行费用低、无污染、免维护等优点，受到世界各国电力工作者的重视。

Overview: Box-type Transformer Station is a moisture-proof, rust-proof, dust-proof, rodent control, fire-proof, theft-proof, insulation, fully enclosed, movable steel cabinets for high-voltage transformer equipment. It is especially suitable for urban electric network construction and transformation. It is a new substation and is so popular for its advantages: flexible combination, easy to transport and install, short construction period, low operating costs, pollution-free, maintenance-free, etc.



工程案例
Project case



工程地点：江苏溧阳
Project site: Liyang Jiangsu

工程简介：6.7m*3.0m*3.2m 变电房，用于太阳能发电系统
Brief introduction: 6.7m*3.0m*3.2m, box-type transformer station for solar power technology system



中节能绿洲（北京）太阳能科技有限公司 CECEP Solar Energy Technology Co., Ltd

包装
Packaging

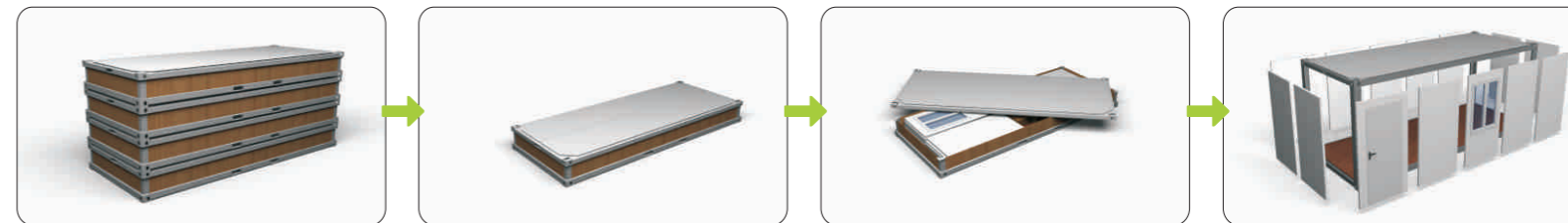

将集装箱房屋顶，底座，立柱及墙板进行拆卸打包（平板包装），最大限度减小运输体积，方便用户现场组装或转场运输。
Roof, bottom frame, column and wall panels of the container house be flat-packed, thus minimizing the transportation volume, can be easily installed on site or be used for transitions transportation.

整体式运输
Assembled loading and transportation:

将尺寸为5850mm*2250mm*2500mm的集装箱房组装完整后装运到40尺高柜，一个40尺高柜可装运2套。
One 40ft HC load 2 sets assembled container house with dimension--5850mm*2250mm*2500mm



拆装式运输
Flat-pack transportation:

方案一：一个20尺柜装运4套尺寸为5850mm*2250mm*2640mm的集装箱房。
Plan A: one 20ft GP load 4 sets container houses with dimension--5850mm*2250mm*2640mm.

方案二：一个40尺高柜装运7套尺寸为6055mm*2435mm*2640mm的集装箱房。
Plan B: one 40ft HC load 7 sets container houses with dimension--6055mm*2435mm*2640mm.



集装箱房安装示例
Install the sample container housing

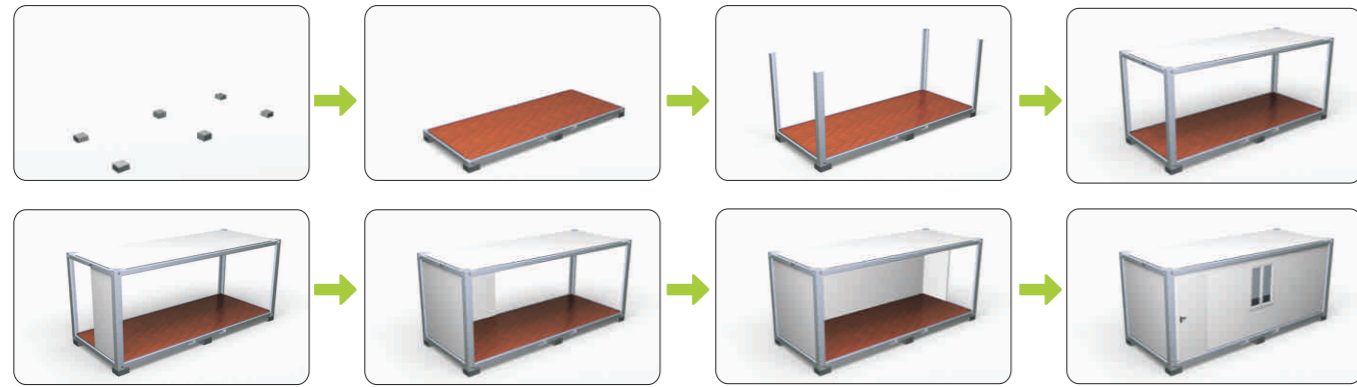

1,平整地面上按尺寸铺好水泥垫块
Lay foundation block on level ground

2,把集装箱底座放在水泥垫块上
Place container house base frame on foundation block

3,安装四根立柱
Install columns

4,安装集装箱顶框
Install roof frame

5,按照墙板编号依次安装墙板
Install wall panels in accordance with the serial number

6,安装墙板完成
Finish wall panels installation

带底座的活动房安装示例
Prefab house with base installation demonstration

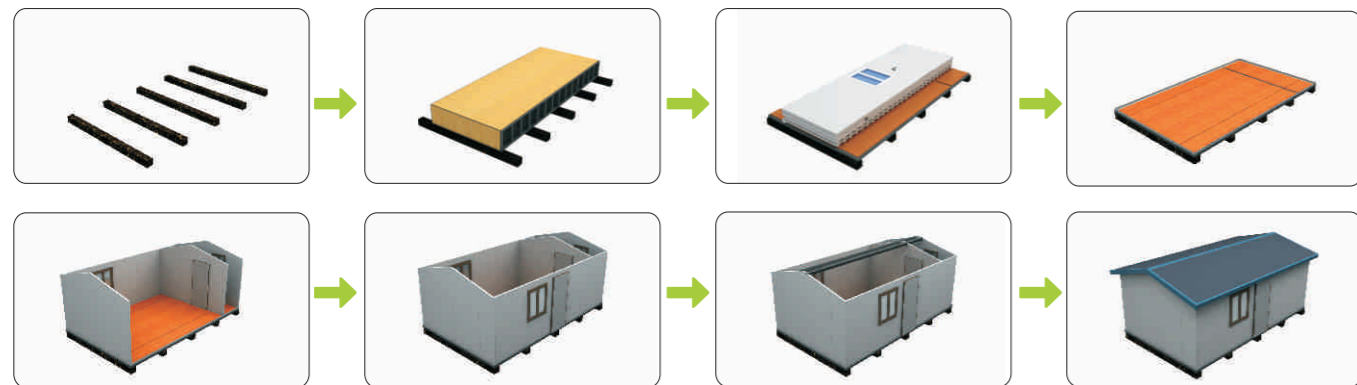

1,安装混凝土地梁
Install concrete ground beam

2,放置折叠房
Put the package on the groundbeam

3,底座固定
Base fixation

4,底座上安装角铝
Install angle aluminum on the base

5,安装墙板
Wall panels installation

6,安装墙板完成
Finish wall panels installation

7,安装檩条
Purline installation

8,防水处理
Waterproofing work

海运箱改造
Modified shipping container



工程地点：美国
Project site: America

工程简介：
40尺海运高柜改造，一室
一厅一厨一卫

Brief introduction:
Modified from 40HQ
shipping container, inside
with one bedroom, one living
room, kitchen cabinet and
one bathroom, inside
decorated with PVC wall
paper



集装箱展厅
Container exhibition hall



工程地点：斯里兰卡
Project site: Sri Lanka

工程简介：
一室一厨一卫带阳台雨棚

Brief introduction:
Container house with deck,
inside with one exhibition
room, one kitchen cabinet
and one bathroom



集装箱宿舍
Container dormitory



工程地点：中国杭州
Project site: Hangzhou China

工程简介：
两层集装箱宿舍，二楼带
阳台雨棚

Brief introduction:
Two floor container
dormitory, combined with 13
container houses, each
container size is 6m*3m.



工人宿舍
Worker's dormitory



工程地点：莫桑比克
Project site: Mozambique

工程简介：
用于工人住宿和办公

Brief introduction:
Used for work and living.



集装箱度假屋
Container holiday flat



工程地点：法国
Project site: France

工程简介：
一室一厨一卫，带阳台雨棚，带太阳能热水器

Brief introduction:
One 20ft container house with deck, inside with one room, one kitchen cabinet and one bathroom, with solar water heater

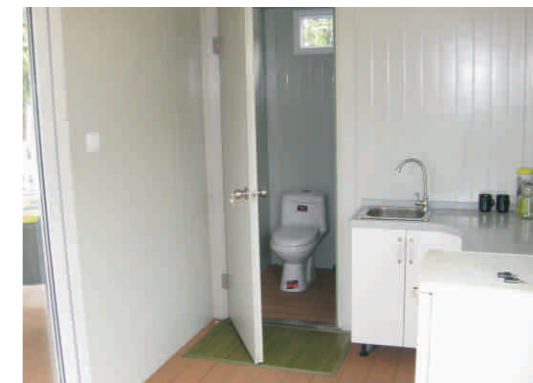

集装箱度假别墅
Container leisure room



工程地点：中国杭州
Project site: Hangzhou China

工程简介：
20尺集装箱拼接而成，用于休闲度假村，带整面玻璃墙，供游客休息观光

Brief introduction:
Connected by 20ft container house, with glass wall, for vacationers' rest and sightseeing



集装箱咖啡店
Container coffee shop



工程地点：巴西
Project site: Brazil

工程简介：
咖啡商店，两侧可展开

Brief introduction:
With double expandable walls for coffee shop



带底座活动房
Ready floored prefabricated house



工程地点：澳大利亚
Project site: Australia

工程简介：
40平米带底座活动房，用于花园房

Brief introduction:
40sqm prefabricated house with floor for garden house



合作伙伴
Partners

